

KaVo ESTETICA® E70

Experience a whole
new dimension in
treatment comfort.



KaVo. Dental Excellence.

Practical comfort has a name – KaVo ESTETICA® E70.

Usefully clever. The ergonomic approach.

In principle, quite simple. With the new ESTETICA generation, we take comfort and ergonomics to a whole new level for you. With intelligent, individualised and efficient components and functions that make life easier for you as a dentist.

The new ESTETICA generation is based on the revolutionary suspended chair approach. This unique approach enables a surprising degree of legroom for both you and your dental team.

Comfort for every day and for your future.

So that everything is just the way you want it, we individually customise your KaVo ESTETICA E70 for you. In every case, you will receive our newly developed, intuitive operating system. Why? To make everything crystal clear during treatment and save you time and stress. With regards to time: The automated hygiene functions free up a surprising amount of time for you and your assistant – after all, you have more important things to do.

Is there something else you would like? No problem. If there is anything you would like to add, it can be retrofitted. We are planning for your future today.

The swing-arm version of the KaVo ESTETICA E70: due to the comfortable, 90cm freely-available length of the handpiece tubings, the working field can always be easily reached.

The table version of the KaVo ESTETICA E70: your dentist element with integrated Display, can be intuitively and efficiently operated - you can fully concentrate on the clinical challenge at hand.

The cart version of the KaVo ESTETICA E70: the dentist's element is extremely mobile, height-adjustable and moves to exactly where you need it. Or you just roll it aside. Upon request, the cart solution is also available with wall adaptation.



Do you also feel that comfort is essential?
Then you need an intelligent treatment
system.

Practical comfort just makes sense.

The reason for the intuitive control logic of your KaVo ESTETICA E70. This spares you the inconvenience of long training periods and accidental misuse during operation. Instead, you can quickly and confidently access all relevant functions. Everything is self-explanatory.

Your legroom is a function of the chair design.

Our design engineers invested a great deal of time and effort in developing an approach that would completely free up the area under the patient's chair of your KaVo ESTETICA E70. The result: A surprising new level of leg comfort. Uncomfortable postures are a thing of the past – you and your assistant can now adopt optimum working positions. Since you and your team feel better with optimised ergonomics, all work becomes that much easier.

True aptitude includes versatility.

On the following pages, read how the dentist and assistant elements, the suspended chair approach and the foot-operated control all translate into practical comfort for your work environment.



Find everything easily.
And like what you find.

Self-explanatory intuitive control logic.

Good news for you: Your control unit has all the functions ready for use when and where you need them. Directly and comfortably access all important functions and save valuable time. Tell your dentist element what you want, and it will take note. You can specify and flexibly retrieve the motor speed and torque for specific indications. The KaVo ESTETICA E70 just became easier to handle – for every clinical procedure.

Increased freedom, increased comfort.

Whether the table or cart delivery version: There are practically no limits to the instrument specification of your dentist unit. Your instrument holder has immediate space for five or optionally six instruments, including the intra-oral camera and remarkably, the table element width remains unchanged. The advantage: Future changes are easily accommodated. Whatever you decide today, you can change tomorrow, thanks to the uniform table size. If you wish, you can also have a USB interface. Each USB interface enables you to accommodate needs by the seamless integration of additional components at any time in the future. Your dentist element may be easily and precisely moved in every direction, just like your service table.

*Only KaVo offers you this option:
Choose either 5 or 6 instrument holders and change this selection if you change your mind at a later date.
It's that easy.*

Endodontics? But of course.

An integrated endodontics package additionally optimises your ergonomic procedures. Optionally installed in your KaVo ESTETICA E70 if you so desire. This noticeably shortens paths for a smoother workflow. In addition, you no longer have to procure additional equipment for endodontic tasks.

Dentist unit and equipment –main features and advantages for you:

- Easy and logical to use
- Modular, configurable and expandable
- Improved micromotor INTRA LUX KL703 LED with wide speed range, from only 100 rpm to 40,000 rpm
- ERGOcam 4 intraoral camera
- Adjustable service table with holder for two standard trays
- Pneumatic brake with sensor (optional)
- USB interface (optional)

It's ergonomical, if it's a KaVo.
It's that easy.

We give you space for more comfort.

Always place your dentist element, where it is most suitable for you. Thus, you always have control, irrespective of whether you wish to work standing-up, sitting-down, with assistant or without. This applies equally to the table, cart and swing-arm versions of your KaVo ESTETICA E70. Choose one of these ergonomic and fully sophisticated versions, based on your personal requirements.

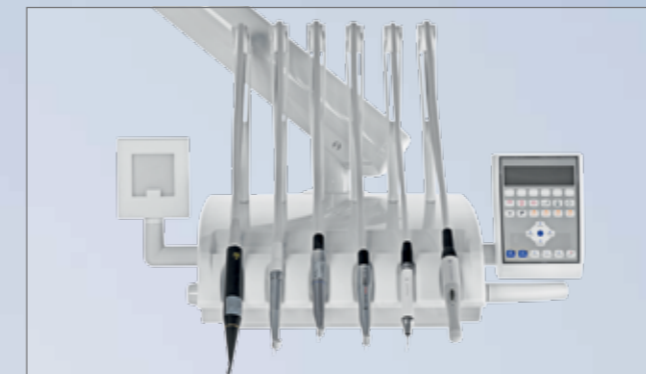

Also the swing-arm version of the dentist element, can be placed where it is most suitable for you.

Optimal hand motion paths – for highest efficiency in every clinical movement.

The swing-arm design of your KaVo ESTETICA E70 is both elegant and highly functional. It assures maximum range of movement and ideal hand motion paths. The intelligent supports for single standard tray, 2 standard trays, and US tray, may be mounted on the right or the left side of the table. Your tray may be tracked horizontally. In the swing-arm version, you can also track it in a longitudinal direction and rapidly attach it to either side. These selection options and flexibility provide optimal support for all clinical treatments.

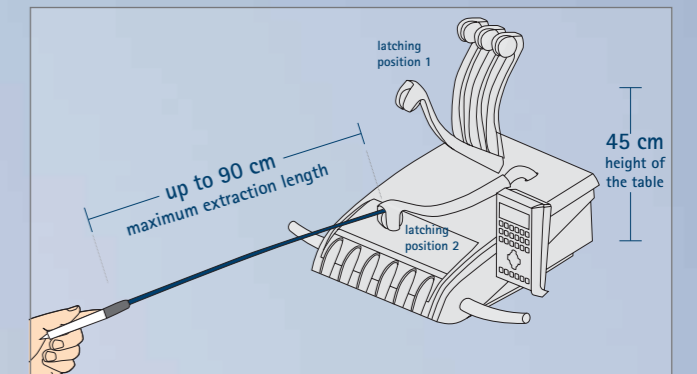

Optimal ergonomic features such as a low table height of 45 cm and well-balanced swing-arm clamp with individually adjustable spring-tension force. Enjoy the freedom of space provided by a maximum handpiece tubing extension of 90 cm.

Intuitive treatment centre – Highlights and advantages for you:

- Intuitive, efficient workflow due to logical and simple operation
- Direct selection key control
- Modular, configurable and expandable
- Relaxed posture as everything is to hand and correctly positioned



Top points for healthy working positions.

An assistant for your assistant? Yes, please!

Optimum work conditions for your assistants make your practice more productive. The assistant element of your KaVo ESTETICA E70, can be adjusted to your nurses preferred treatment positions and provides full support with all the instrumentation that is required. Integrate e.g. an LED polymerisation light, or perhaps additional surgical suction. Everything is arranged in an ergonomically perfect manner.

Assistant unit – Main features and advantages for you:

- Easy to use with direct keys
- Additional instruments may be fully integrated, such as the intraoral camera
- USB interface (optional)
- Maximum flexibility from the adjustable height and large, pivotable section

*Easy to use with direct functions.
Always quickly accessible: Chair, hygiene and instrument functions.*



Your healthy posture is key.

Feel free! The resulting freedom of movement is provided to you by the innovative suspended chair design of the KaVo ESTETICA E70. There is nothing but air below the patient's chair. You and your assistant are therefore both able to adopt the most comfortable and/or efficient working position for each stage of the patient's treatment protocol. Your procedures become smoother and much more ergonomic. Pure comfort for you, day in and day out.



The lowest working position of 350 mm also allows a natural body posture when treating seated patients. The highest working position of 900 mm allows you to treat supine patients while standing – even dentists over 1.80 m tall.

Treat your patients from a standing or sitting position.

Would you like more freedom? No problem. Your KaVo ESTETICA E70 adjusts to your body size and your desired posture. You can vary the chair height from 350 mm to 900 mm. At its highest position, you can treat supine patients while standing, even when you are over 1.80 m tall. At its lowest position, you can assume a natural, seated posture while treating supine patients. Adjust the chair height to practice dentistry the way you want.

The suspended chair – Main features and advantages for you:

- Suspended chair for optimum leg room
- Infinitely variable chair positions from 350 mm to 900 mm for comfortable working while sitting or standing
- Noise-optimised chair drives with soft start and soft stop
- Trendelenburg movement

Tailored to your comfort from head to foot.

Gentle foot movements instead of a multitude of manual movements.

Your KaVo ESTETICA E70 responds to both hands and feet. By gently touching the switching surfaces of your multi-functional, KaVo foot-operated control, you can access every instrument and chair function as well as all multimedia functions for your KaVo ESTETICA E70. Use your foot to start all repetitive treatment processes. The foot control features a special valve for regulating the compressed air pressure of the turbine as well as the intensity of all other instruments. This helps you to gently and precisely control your handpieces.

If you don't want to have cables across the floor, you can select the special wireless foot control for the KaVo ESTETICA E70 instead of the cable version. Thus increasing your comfort even further.

Hygiene is a natural result.

There is hardly a more important way of preventing cross-infection than avoiding contact. Your patient's chair and the instruments of your KaVo ESTETICA E70 are fully commanded by the foot control. You do not have to touch the dentist element during treatment, and can therefore effectively reduce cross-contamination within your dental practice. The wireless foot control has no cables that need to be cleaned, or over which one might trip.



No more muscle cramps.

With conventional units, to maintain a set instrument speed/intensity, the foot control has to be depressed by exerting a continuous, consistent muscular force, which then leads to discomfort, muscle fatigue and cramps. Not so with KaVo -- The type of muscular activity, which can cause fatigue over time, is avoided. Instead, the gentle, effortless right-left pivoting movement of your foot precisely controls the KaVo ESTETICA E70. Your leg muscles therefore remain relaxed even after long periods, irrespective of whether you are sitting or standing whilst working.

Foot-operated control – Main features and advantages for you:

- Control chair, instrument and multimedia functions
- No fatigue results from the left/right pivoting foot movement
- Easy, precise speed control
- Improved hygiene, especially the avoidance of cross-infection
- Can be placed anywhere under the patient chair because of its design
- Wireless foot control (optional) with delay-free radio signal transmission for increased health & safety without cables

Substantially more comfortable than „accelerate and brake“ design: Speed can be precisely controlled with gentle right/left pivoting movements of your foot. There is no long-term tightening and cramping of the muscles.

Do you have your own way of doing things?
Then you will enjoy your new freedom.

Individual comfort has many facets.

Just like you. It is therefore a good idea to keep all your options open. It's easy: Choose the features you want and your preferred colours to correspond with the treatments that you provide and your individual preferences. The various components are seamlessly integrated into your treatment unit. What if you decide to change your mind at a later date or want to specialise in different disciplines? No problem. You can easily and comfortably retrofit and update at any time.

Personality is expressed in a variety of ways.

In the following pages, read how new colours and functions can enhance your routine and how your KaVo ESTETICA E70 can be comfortably customised to you and your patient's needs.

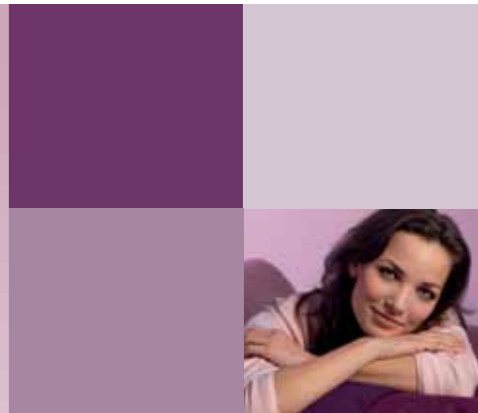

There is no disputing taste – especially not your own.

Individually adapt the design to your practice.

Do you have classical tastes, or do you want to set accents with your own colour combinations? Both are possible. Your KaVo ESTETICA E70 is as individual as yourself. With the timeless modern design and the numerous varieties of colour and upholstery, practically every wish can be met, and the treatment unit can be precisely adapted to the environment of your practice. Your personal colour selection provides an individual ambience. Anyone who enters your operating rooms will feel at home.

Modern, happy, warm, sprightly, cool, minimalist, individual –select your personal ESTETICA E70 from over 100 possible combinations.

Metallic paint colours



Solid colours

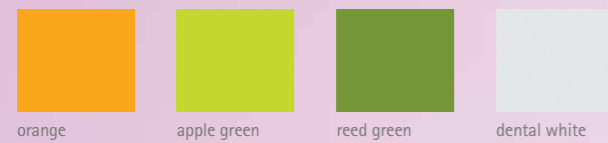

Upholstery colour

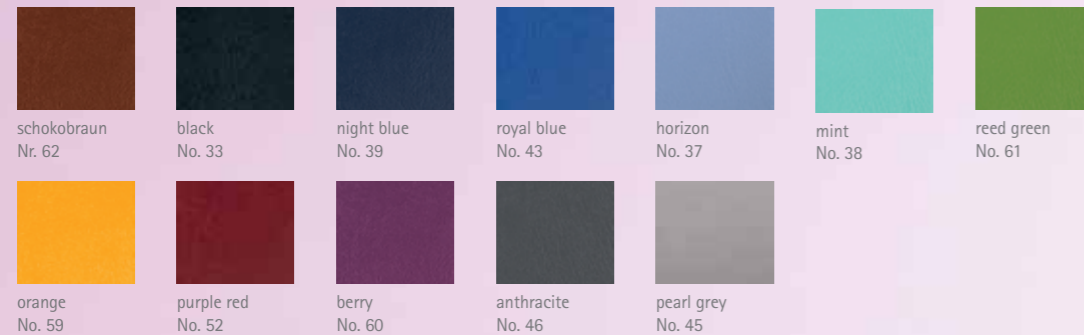

Colour and design – Main features and advantages for you:

- A wide selection of different paint and upholstery colours
- Individual colour combinations are possible
- Timelessly modern design, high-quality materials

Suspended and lying down: Two different worlds.

The suspended chair provides comfort and safety.

Your patients can fully relax on your KaVo ESTETICA E70 with the automatic Trendelenburg positioning function. The footrest of the patient chair raises or lowers depending on the backrest angle. The elevated position supports your patient's circulatory system. In addition, overextension and compression are avoided when changing positions from maxilla to mandibular treatment – no „stretching effect.“ The patient's head remains in the same position on the headrest; you do not have to adjust the backrest or headrest.

Another ergonomic feature: Lengthwise adjustment of the backrest via the integrated spine length adjustment (only with the Comfort backrest). The articulated movement of the backrest simulates the pivot axis of the hips and therefore corresponds to human anatomy.

To prevent your patient from being startled during treatment, the noise level of the drives of your KaVo ESTETICA E70 has been reduced. Tension melts away; the atmosphere is anxiety free. Your patients will therefore be motivated to return.

Your patients should feel comfortable no matter who they are.

For optimum patient comfort, you can choose the Comfort backrest for the patient chair of your KaVo ESTETICA E70. This special backrest allows your patients to remain comfortable in a supine position even during long treatments. The large surface stabilises the patient's body and is even suitable for patients with rounded shoulders, or spinal curvature.

The Progress backrest is another attractive option. Your patients are thereby more relaxed, which is a substantial advantage especially when treating children. The particularly flat backrest surface gives you greater legroom.

Both backrests offer the following advantages: They are ergonomically designed for your patients – for young, old, large and small, independent of their body size.



Progress backrest: Correct working posture and optimum access for the dentist, especially when treating children. Comfortable position for persons over 1.90 m tall.



Comfort backrest: Maximum comfort and wide shoulder resting surface for patients. Good shoulder support for patients over 1.95 m tall.

Patient positioning – main features and advantages for you:

- Two backrests with soft upholstery to choose from
- Headrests: Motorised or manually adjustable
- Left or right arm rest as desired
- Spine length adjustment and backrest arc segment
- Child seat and magnetic wedge attachment



Particularly comfortable: The lengthwise adjustment of the Comfort backrest optimises ergonomics and patient comfort via the integrated patient spine length adjustment

** Only with the „Comfort“ backrest.*

Your advantages at a glance.

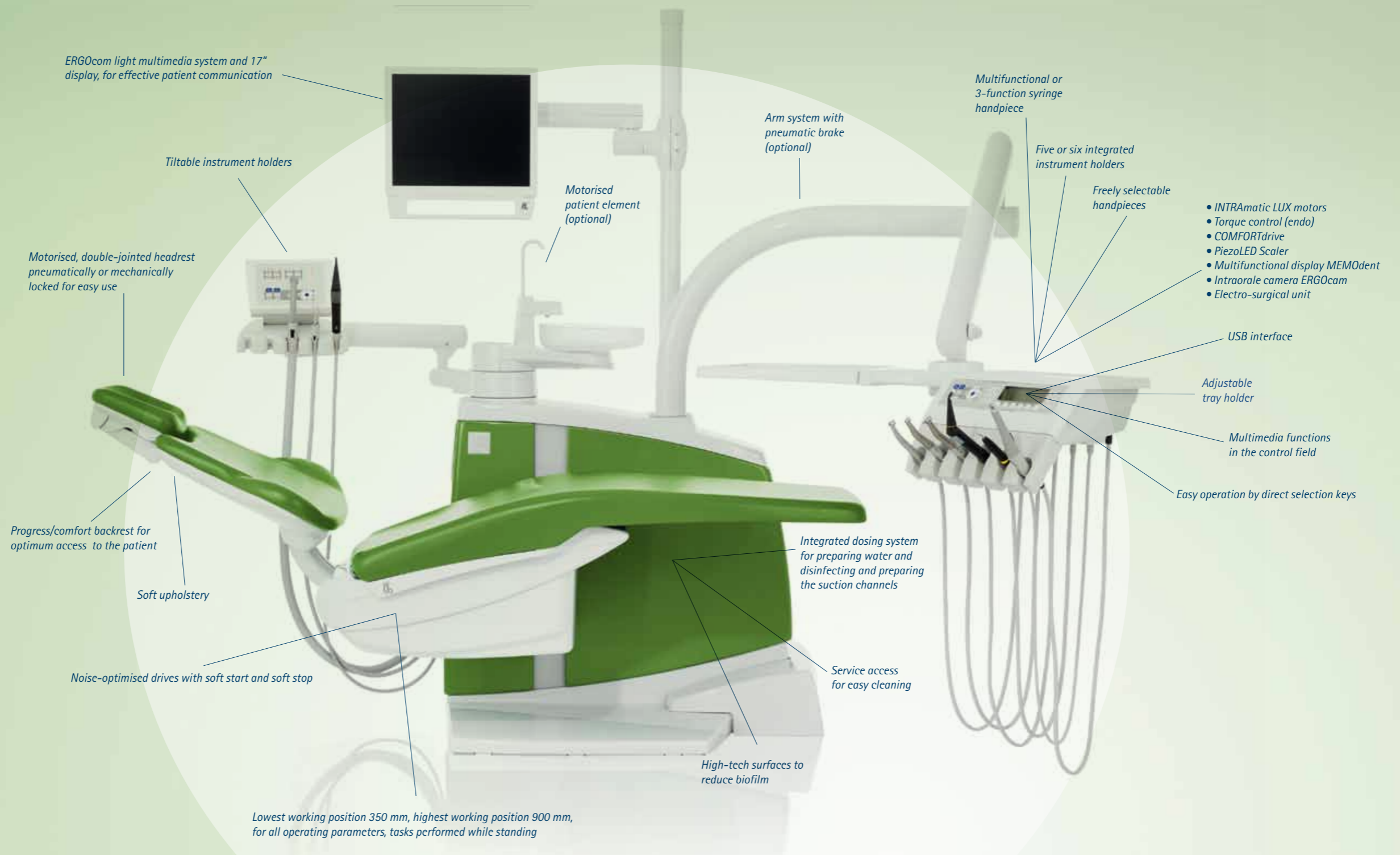

Everything is visible at one glance. Your entry into the digital world of dentistry.

Realise speed and comfort through the ERGOcom multimedia system.

Connect all your systems easily: the computer at the practice, the treatment centre, and other media. Through this connection technology, you can call-up the most recent findings of your current patient on the 17" display of your KaVo ESTETICA E70 - together with the pertinent X-ray, microscope, and camera images or images from the PC. Without any delay and without you or your assistant having to leave the room. ERGOcom light is your simple, optional solution for this purpose.

Your multimedia system is ready to go.

To use your ERGOcom light, you need neither a PC connection, nor do you have to lay cables. Its functions can be controlled either by foot control or through the dentist element of your KaVo ESTETICA E70.

More light and precision for perfect intraoral images.

More vision, more details - thanks to the new intraoral camera ERGOcam 5. Explain treatment to your patients, by using impressive images, or document your treatment success. Operation using the slide-control, with its defined-focus positions, is very easy. The high depth-of-focus and the extraordinary colour-rendering, based upon state-of-the-art CMOS chip technology, are very impressive, particularly for highly-detailed images in the gingival area.

The intraoral camera ERGOcam 5 offers perfect ergonomics and delivers impressive image results, thanks to its 40,000 LUX light intensity.

ERGOcom light Multimedia – Highlights and advantages for you:

- Camera images may be displayed without a computer
- Simultaneous display of four camera images
- Camera, computer, microscope and x-ray images viewable on the treatment centre's monitor display
- Hygienic operation by foot control



Automatic marketing of your services. Make use of potentially unproductive "waiting time" by informing your patients about the services that your practice offers.

This is how you will work tomorrow. Have a look at the future.

SMARTdrive power and sensitivity conveying you into the future.

Precise, efficient, and time-saving working conditions are produced by the new SMARTdrive motor control, with full torque and particularly vibration-free start-up characteristics, even in the low speed range of 100 rpm. Due to the broader speed range, all straight and contra-angle handpieces may now be used in a more versatile manner, which extends the range of applications of each handpiece.

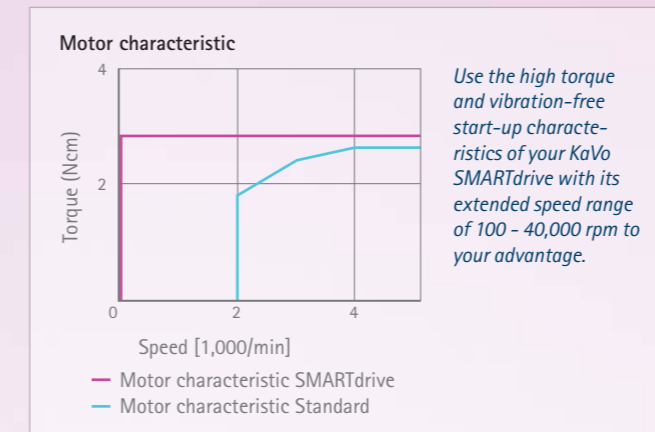

Treat your patients expeditiously and effectively with the PiezoLED.

The new PiezoLED scaler provides you with high-precision and effective tooth cleaning for your patients. KaVo CARE technology allows you to apply its power extremely evenly and with optimum linear tip movements, from a sinusoidal signal. Teeth and gingivae remain undamaged, even in delicate areas, due to the higher accuracy of your work.

The circular light array of the LED's produce optimum viewing conditions for you and in combination with the lightweight and ergonomic design, you can always treat your patients under ideal conditions.

PiezoLED: Innovative KaVo CARE Technology with intelligent feedback control for the highest standard of patient treatment.



Evolution is a question of adaptation – and equipment.

The dentist and assistant elements are highly flexible.

You know precisely what you want? There is practically no limit to the instrumentation for the dentist and assistant elements. Equip yourself and your employees to best conform to your style of work. The KaVo ESTETICA E70 adjusts to your personal requirements and those of your team, and is open for future instruments and expansion.

Always ready for the future.

Independent of your specialty or whether you want to avail yourself of the entire spectrum, your ESTETICA E70 is completely adaptable to you and your wishes: Endodontics, high-frequency surgery, saline solution pump, MULTIflex and INTRAmatic coupling, X-ray viewer, multifunction syringe and much more. As universal interfaces, the coupling systems of your dentist element are multi-talented.

Individualised features – main features and advantages for you:

- Flexible features for the dentist and assistant elements
- Supports different specialities as needed
- A wide selection of additional features, retrofitable in the future
- Value-retaining, standardised interfaces for easy use and expansion

A strong performer – making your work easier.

Impressive power and handling – KaVo INTRA LUX KL 703 LED.

With the new, maintenance-free, brushless micromotor KaVo INTRA LUX KL 703 LED, you will experience top performance. It is SMARTdrive-optimised and offers a wide speed range from 100 rpm to 40,000 rpm with a 1:1 „direct-drive“ handpiece. Thanks to its weight reduction of 30% and its 25% smaller design, it offers perfect ergonomics and optimum balance, with excellent distribution of weight. It offers more than just sufficient power at any treatment situation and enables more precise handling, with simultaneous stress-free working. For simple hygiene, the INTRA LUX KL 703 LED can be sterilised and features a long service-life, 25,000 LUX LED, for perfect illumination. Extraordinary performance characteristics, for extraordinary treatment results, day after day.



KaVo INTRA LUX KL 703 LED: smaller, lighter and with perfect distribution of weight.

More power, more speed, less weight – KaVo COMFORTdrive.

COMFORTdrive represents a new handpiece era from KaVo. COMFORTdrive combines the advantages of turbines and speed-increasing handpieces, into a single solution. With its speed range from 30,000 rpm up to 200,000 rpm, it is suitable for all clinical procedures and offers perfect ergonomics. The balance-point is perfectly positioned, so that there is less strain on your wrist, hand and fingers. Enjoy easier, more efficient and more relaxed working, with COMFORTdrive and COMFORTbase, every day.

Individualised features – Highlights and advantages for you:

- Integrated SMARTdrive for precise work in the low speed range
- Improved micromotor INTRA LUX KL 703 LED, with wide speed range from 100 rpm to 40,000 rpm
- PiezoLED for effective and time-saving treatment of your patients
- Latest handpiece technology with COMFORTdrive for even more relaxed and efficient preparations
- Standardised interface for easy connection of external devices and flexibility for the future
- A wide selection of additional, intelligent features, which may be retrofitted in the future

Stay prepared for the future – thanks to the USB-interface technology.



Simply connect additional selected USB devices through the USB interface of your KaVo ESTETICA E50. It is particularly easy as connecting a USB device usually necessitates no additional settings to be made. Your treatment centre automatically recognises what has been connected to it.

KaVo COMFORTdrive is your powerful, light-weight device, with almost imperceptible operational noise.



Wouldn't it be nice to have more time?
Then you need an efficient
treatment system.

**Comfort without efficiency is no
comfort at all.**

Your KaVo ESTETICA E70 promotes timesaving, efficient procedures. In our opinion, being rushed is a waste of time. Your treatment unit takes over tasks that can be productively automated for both you and your assistant. Such as hygiene. A genuine, measurable improvement for your practice.

Precision work cannot be rushed.

All the features of your KaVo ESTETICA E70 are completely integrated and optimally balanced -- every move and action is natural and easy. Work processes are ergonomically optimised; the workflow takes less time -- for a more relaxed approach. Efficiency is a natural by-product.

Quicker and more reliable.

On the following pages, read how you, your team and your patients can experience greater safety despite substantially quicker routine hygiene tasks. Also learn how you can profit from a smooth, efficient workflow and remain open to innovations in the future. With superior quality and comfort.



Performance with hygiene.



Save time with automated hygiene.

With the automated, permanent disinfection system of your KaVo ESTETICA E70, you avoid time-consuming hygiene tasks. OXYGENAL prevents microorganisms from spreading in your treatment system during normal operation. In addition, the intensive disinfection maintains the quality of the cooling spray and rinsing liquids, even during long downtimes. There are no blind ends in the entire plumbing system. The unit features a ring water main in the dentist unit, which permanently rinses the entire system and prevents the accumulation of pathogens, which can propagate into biofilms.

Safety through automated disinfection.

Safety is primary. The hygiene functions of your KaVo ESTETICA E70 prevent treatment errors, protect you, your staff and your patients, whilst increasing the reliability of your system. The automated "Hydroclean" function uses water to clean both the liquid waste and suction systems, which includes the suction hoses, and disinfects these with the fully automated dosing of DEKASEPTOL gel. Manual steps are no longer needed, and your personnel never come into physical contact with disinfectants.



Oxymat und Dekamat, both integrated in the device, bring standardised and automated hygiene to your practice. This means less work for your assistant. Furthermore, automated care promotes operational reliability.

No opportunity for germs thanks to the permanent rinsing of the water ring main system.

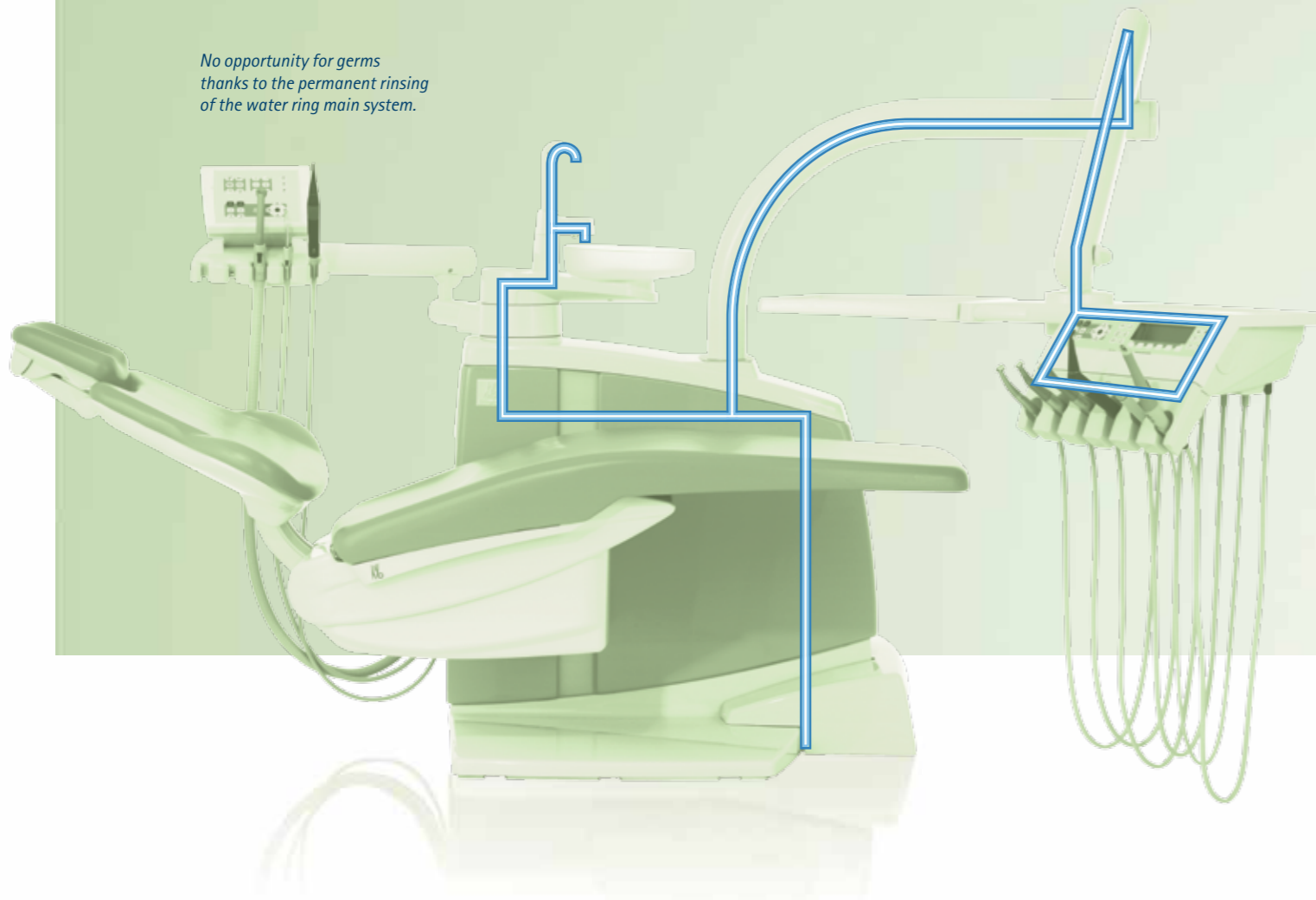

Automatic rinsing programme in accordance with RKI.

Saving even more time. The automated rinsing program facilitates daily flushing of all water lines. Simply activate the variable rinse time by the push of a button.

Improved protection through anti-reflux system.

A small idea with a big impact. Anti-reflux technology in KaVo instruments and motors isolates and protects the water supply system. This in turn protects your patients and prevents contaminated spray coolant from being sucked back into the treatment unit.

Increased comfort through motorised pivoting spittoon.

Selection of the optional, motorised, rinsing position, automatically swivels the spittoon towards the patient before commencing the bowl flush function. This facilitates patient comfort during mouth rinsing. The bowl flush ceases and then the spittoon automatically swings back to its starting position, as soon as the patient is returned to any treatment position.

Important components, such as the porcelain spittoon bowl and tumbler filler coaster may be thermosdisinfected.

Time savings in hygiene – main features and advantages for you:

- Automated and standardised hygiene
- Simple and faster cleaning
- Removeable parts
- Increased health & safety through anti-reflux systems



Grab handles, silicone mats, spittoon bowl, handpiece holders, and swing-arm clamps are easy to remove, disinfect and replace. The suction filters have hygienic handles which makes them easy and safe to clean/replace.

Standard ancillary air channels around the cannula connection provide essential by-pass air (2006 Study - University of Dresden), even if the patient's soft tissues have been aspirated into and have occluded the cannula. The uninterrupted aspiration prevents contaminated fluids from flowing backwards, and therefore contamination through reflux is practically eliminated. This is achieved with all standard cannulas now available on the market.



The source of a perfect workflow.

Your dentist element accelerates procedures.

Since speed is frequently important during treatment, your dentist unit quickly supplies information and controls all important functions.

How can you remain aware of everything at this pace? Your dentist unit has all the answers you need. For example, patients can be quickly and comfortably positioned. Its (optional) sensor brake immediately deactivates when the grab handle is touched and reactivates when it is released. Its service table can also be swivelled. In just the way that is necessary.

Short paths simplify work.

Where should I put the surgery light and X-ray machine? Where is the best place for ancillary devices? What is the best way to install the microscope, and where does the monitor belong? Only one answer is necessary: The Centro mounting system solves your individual requirements for space and logistics. From lightning to trays – the Centro holds your additional devices arranged according to your wishes. It further enhances ergonomics and gives you the freedom to concentrate on the essentials.

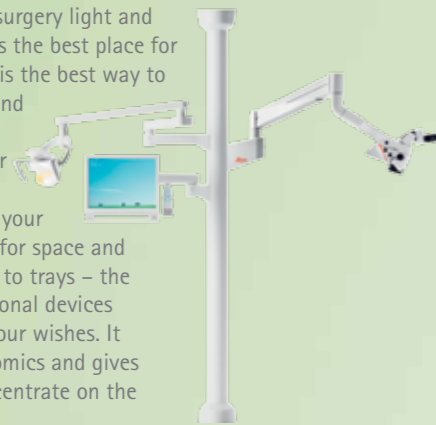

The optimised workflow measurably shortens your data paths during treatment. Capitalise on the timesavings from the integrated endodrives as you wish – fewer paths from integrated technology and optimised ergonomics.

Paths with a conventional treatment unit.

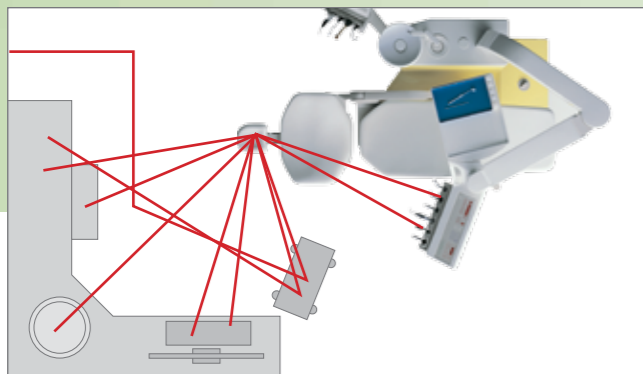

Paths with the new KaVo ESTETICA E70.

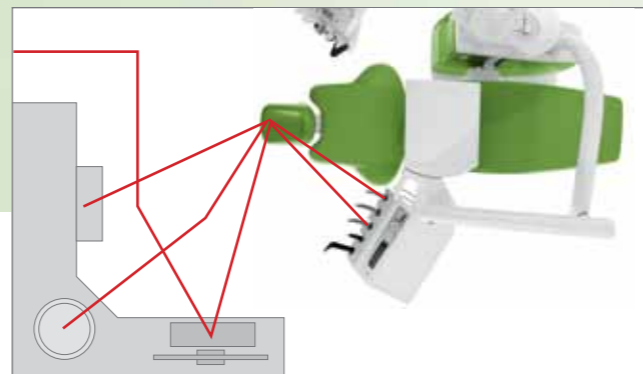

More efficiency for the entire team.

Teamwork is required in your practice. The assistant element can therefore be flexibly sited, pivoted, and adjusted in height and its control panel employs the same colour-coded buttons found on the dentist element. Since half the job is clear communication, the assistant element, dentist element and patient chair of your KaVo ESTETICA E70 are perfectly tailored to each other. There are no detours or interruptions.

Perfect workflow – Main features and advantages for you:

- Complete integration of all components for endodontics, X-rays, etc.
- Systems harmonised with each other
- Comprehensive adjustment options for all components
- Information systems to promote smooth, seamless procedures
- Sensor brake in the dentist element (optional)
- Balanced movements

Quality provides the superior edge.

Manufactured in Germany. You can count on it.

The KaVo ESTETICA E70 was tested in extended trials of longer-than-average duration. No problems arose, even in simulations of extremely heavy use. The ergonomic features were of course also subject to rigorous testing. The valuable assistance and input from experienced dentists during development, helped us refine and continuously optimise individual options for the unit, covering a diverse range of demands from basic to very advanced dentistry. With superior results; tested and certified according to exacting German and international standards.

Outstanding quality – main features and advantages for you:

- Solid construction with superior materials
- Precise processing according to superior standards of quality
- Fine harmonisation and gradations for all functions
- Maximum reliability from comprehensive long-term trials

We offer you maximum comfort and more.

With your KaVo ESTETICA E70, you experience both superior comfort and functions. In every detail, and in the overall interaction of the components. We understand that you require fine-tuning and sensitive gradations for your work. Superior manufacturing is required to achieve a treatment unit that enables superior quality and comfort when working. Your KaVo ESTETICA E70 offers the highest standards of quality.



High-quality surfaces and materials manufactured with proven KaVo quality.

Your wish, your satisfaction

	T	C	S		T	C	S
Patient chair				Assistant unit			
Soft upholstery	●		●	Spray mist suction	●		●
Child's seat	○		○	Saliva ejector	●		●
Backrest				Second saliva ejector	○		○
Comfort	x		x	Triple-function syringe handpiece	○		○
Progress	x		x	or multifunctional syringe handpiece	○		○
Headrest				LED polymerisation handpiece	○		○
Double-jointed, mechanical	x		x	Hydrocolloid connection	○		○
Double-jointed, pneumatic	x		x	USB interface	○		○
SOMATIC with electric motor	x		x	Support for tray holder	○		○
Magnetic wedge attachment	○		○	Height-adjustable arm	●		●
Arm rest				DIAGNOdent holder	○		○
Right	○		○	Device body			
Left	○		○	Glass spittoon	x		x
Dentist unit				Porcelain spittoon	x		x
1st Turbine hose	●		●	Motorised spittoon	○		○
2nd-5th Turbine hose	○		○	Permanent disinfection	●		●
1. KL-motor 703	●		●	Intensive disinfection	●		●
2.-5. KL-motor 703	○		○	HYDROclean	●		●
Integrated torque control (Endo)	○		○	AQUAmat	●		●
COMFORTbase	○		○	DEKAmat	●		●
3-function syringe handpiece	●		●	Warm water heater	●		●
multifunctional syringe handpiece	○		○	VACUstopp	●		●
PiezoLED	○		○	Supply system			
Spray heating for instruments	●		●	DVGW water block	●		●
Anti-reflux for instruments	●		●	Additional device connection	○		○
Memodent multifunction display	●		●	Disposal system			
HF electrosurgery	○		○	External suction	●		●
ERGOcam 4	○		○	Dürr amalgam separator	○		○
Small X-ray viewer	○		○	DÜRR Separator	○		○
Large X-ray viewer	○		○	Miscellaneous			
Service table 1568	-		○	Wireless foot control	○		○
Physiological saline solution	○		○	KAVO OPERATING LIGHT 1410	○		○
Adjustable service table	●		-	Operating light mounting post	○		○
For two standard trays				ERGOcom light	○		○
USB interface	○		○	ERGOcom 4	○		○
Pneumatic brake with sensor handle	○		-	DEKASEPTOL BASIC SET	●		●
Holder for two standard trays	-		x				
Holder for one standard tray	-		x				

● Standard equipment ○ Optional equipment x must be selected - not deliverable



LED polymerisation light



KaVo INTRA LUX KL 703 LED



Small X-ray viewer, 5 cm x 5 cm



Panorama-Röntgenbildbetrachter: am Zahnarzttelement oder am Servicetisch positioniert



KaVo electrosurgery device



DIAGNOdent holder for the assistant element



KAVOLUX 1410 C Operating light

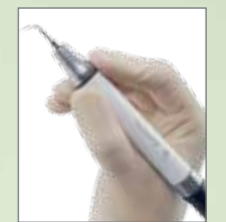

KaVo Piezo LED for calculus removal



ERGOcam 5 intraoral camera



Trägersystem Centro



PHYSIO 5007 work stool



External equipment connection External equipment easily provided with water, air and electricity.



Double-jointed headrest, mechanically locked



Double-jointed headrest, pneumatically locked



Motorised headrest



Magnetic wedge attachment

Additional information can be obtained at: www.kavo.com



KaVo. Dental Excellence.