

KaVo ESTETICA® E50

The best things in life  
are simple.



KaVo. Dental Excellence.

Many intelligent details, one simple goal.  
Working intuitively.



**What does a treatment centre that convinces through its simplicity have to include?**

In order to optimise and simplify dental procedures, you first have to do one thing: ask questions. What are the prerequisites that need to be met for you to operate your treatment centre completely intuitively. What feel must a patient chair have to make your patient want to return to you? What makes a foot control a convincing ergonomic tool? How can your assistant work more efficiently and support you optimally? Which kind of hygiene concept saves you and your staff valuable time each day and optimally protects everyone?

Find the answers to all these questions on the following pages.



*Focus fully on your clinical work. Your treatment centre provides comprehensive support.*

If you treat many patients, you mainly need one thing.  
A treatment centre that may be operated intuitively.

**Pure intuition: Command all functions rapidly and conveniently.**

Though it is obvious, it cannot be taken for granted: All control functions of your dentist element are where you expect to find them. No time-consuming familiarisation, leafing through the manual and searching while treating a patient is required, due to the intuitive control interface, using direct keys that do not have complicated double functions assigned to them.

Start working straight away. The new, modern software runs in the background to ensure trouble-free functions. Direct keys for standard functions, the clear design, and the KaVo colour scheme render things even easier for you. Saving you valuable time during each treatment.

*The intuitive control panel display, makes your KaVo ESTETICA E50 quick and easy to use. Just take out any handpiece and see all important information with a single glance.*

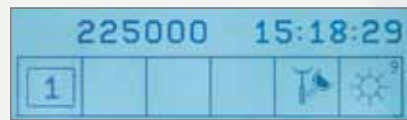

**The handpieces being freely selectable, allows you to remain flexible for the future.**

You are absolutely free to select your preferred handpieces and always remain flexible due to the KaVo coupling system – your universal interface. If the focus of your treatments should shift during the course of time, changes are easy to implement at any future date. Integrated technologies such as KaVo SMARTdrive motor control make you well-prepared for the future. You are free to upgrade your KaVo ESTETICA E50 through Endodontic and HF electrosurgery functions or to supplement it e.g. with innovations like the PiezoLED ultrasonic scaler and the most modern drive system on the market – KaVo COMFORTdrive.

*You want even more? Use the MEMOdent to easily and reliably recall stored parameters for each handpiece, for repetitive treatment steps. (There are 3 program levels for up to 6 dentists).*

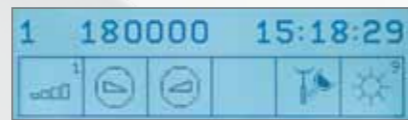

*When you purchase your treatment centre, you may elect to have five or six handpiece holders and have each of these positions configured to meet your specific needs.*



It's ergonomical, if it's a KaVo.  
It's that easy.

**We give you space for more comfort.**

Always place your dentist element, where it is most suitable for you. Thus, you always have control, irrespective of whether you wish to work standing-up, sitting-down, with assistant or without. This applies equally to the table and swing-arm versions of your KaVo ESTETICA E50. Choose one of these ergonomic and fully sophisticated versions, based on your personal requirements.



*Also the swing-arm version of the dentist element, can be placed where it is most suitable for you.*

**Optimal hand motion paths – for highest efficiency in every clinical movement.**

The swing-arm design of your KaVo ESTETICA E50 is both elegant and highly functional. It assures maximum range of movement and ideal hand motion paths. The intelligent supports for single standard tray, 2 standard trays, and US tray, may be mounted on the right or the left side of the table. Your tray may be tracked horizontally. In the swing-arm version, you can also track it in a longitudinal direction and rapidly attach it to either side. These selection options and flexibility provide optimal support for all clinical treatments.

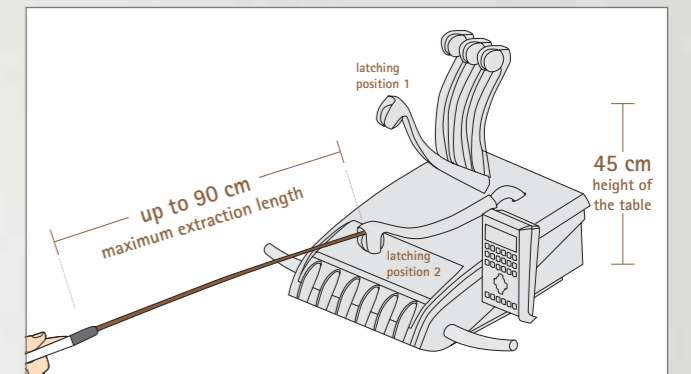

*Optimal ergonomic features such as a low table height of 45 cm and well-balanced swing-arm clamp with individually adjustable spring-tension force. Enjoy the freedom of space provided by a maximum handpiece tubing extension of 90 cm.*

**Intuitive treatment centre – Highlights and advantages for you:**

- Intuitive, efficient workflow due to logical and simple operation
- Direct selection key control
- Modular, configurable and expandable
- Relaxed posture as everything is to hand and correctly positioned

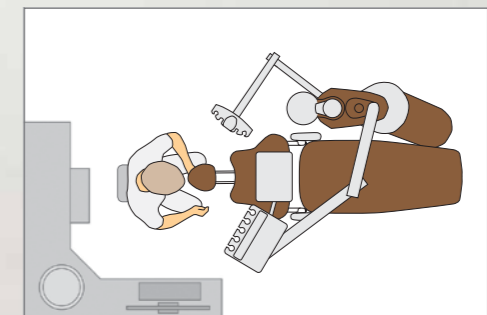

*Whether you work two-handed, or four-handed with your assistant, the dentist element, the tray support, and the assistant element may be positioned optimally due to their impressive range of movements.*

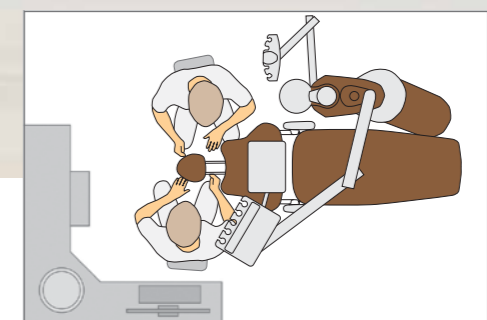

# This makes your patients feel comfortable: Just sit down and relax.

## For correct positioning of your patients, dependent upon their specific needs.

If your patients are properly positioned on the operating chair and feel comfortable, they tend to fidget much less. The benefit to you: This allows you to work much more efficiently and to fully focus on the treatment at hand. Soft upholstery, ergonomic seat recess and lumbar support ensure optimal patient positioning. Moreover, you can raise the rear of the seat manually, when treating children.

## The efficiency of your operatory area is optimised.

Position the head of your patient such that it is most convenient for your method of practice – suited to the indication and individual prerequisites of the patient. Simply adjust the double-jointed headrest appropriately. You can select from versions having either a knob or push-button release. The flexible, two-position head cushion of the push-button version, supports the neck and is especially well-suited for treating children.

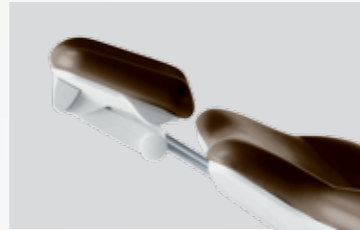

*Raising the rear of the operating chair's seat, allows you to position patients of all sizes comfortably, especially children: Patient's knees adopt a normal, relaxed and comfortable resting position. Patients are not subjected to annoying stretching or compressing forces, when the chair is in motion.*

*Simply comfortable: The double-jointed headrest can be operated with just one hand, has a rotatable head cushion, and provides a perfect, comfortable neck support for your patients, even during long treatment sessions.*

*Your patient chair can be adjusted optimally for all treatment indications between a very low minimum position of 395 mm and a very high maximum position of 780 mm.*

## KAVOLUX 1410 makes patients beam.

Simplify your work with the homogeneous, colour-corrected properties of the KAVOLUX 1410 operating light. The precise illuminated field and continuous control of the illumination intensity in the range from 8,000 through 30,000 LUX, provides you with perfect vision while your patients experience no glare or uncomfortable temperature increase. You can rotate the ground glass reflector through 180° and benefit from its ergonomic design. Also benefit from the low risk of prematurely curing composite fillings compared with conventional, LED technology operating lights.



*Safety for you and your patients: The lamp housing is sealed and provides shatter protection. The handles may be removed and subjected to thermodisinfection or sterilisation, according to your infection control protocols.*

## Patient's chair and operating light – Highlights and advantages for you:

- For optimal and flexible positioning of all patients
- Comfortable chair treatment surface due to soft upholstery and an ergonomically-shaped, fully-contoured seat recess with integrated lumbar support
- Select from two flexible headrest options
- Highest position, suitable for working when standing
- Operating light KAVOLUX 1410 with shadow-free illuminated field, having daylight quality

## Comprehensive comfort extends all the way: to the tips of the toes.

### Ergonomic and hygienic work procedures without having to exert high, continuous pressure through your foot.

Command all chair, handpiece, and multimedia functions by foot control. It is very easy. As your foot performs an ergonomic right-left lateral movement, your leg muscles are not exposed to constant tension, do not fatigue, and remain relaxed and stress-free. The risk of cross-contamination is eliminated, because you use the foot control not your hands to control the functions.

*With or without a cable: Position your premium, multi-function foot control according to your specific needs. The wireless version affords the most freedom and even better hygiene, as there is no cable involved.*

### Time and safety are on your side with MEMOdent.

The MEMOdent function allows important parameters, such as speed, direction, coolant, and cold light intensity, to be recalled easily through the mid-centring of the pivoting pedal of your premium, multi-function foot control. Just a light touch with the foot is enough to rapidly and reliably recall recurring treatment sequences.

### The innovative wireless technology gives you all the control you need.

Your wireless, premium foot control works interference-free, safely and cleanly: The high performance rechargeable battery holds enough energy for approx. two months, and yet its recharging time is but three hours. Of course, there is no self-discharge or memory effect, so you can rely on your wireless foot control at all times. And: It has no cable that may create a trip hazard and additionally needs to be regularly cleaned.



## Many things are made easier for your assistant. Everything is made effective and efficient for you.

### Direct selection keys promote easy familiarisation and speedy clinical procedures.

The 'key' to allow your assistant to become more efficient is one of the direct selection keys on your treatment centre. These allow the assistant to activate all functions touching just one, relevant key: tumbler filler, spittoon bowl flushing, intensive disinfection, HYDROclean, operating light, and treatment step timer. There are no superfluous keys, only sensible functions.

### The assistant element allows your staff to reach high performance status.

The swivelling range of the assistant element, is designed rationally, allowing for easy access. Your assistant is free to position the control element according to individual need. The optional height adjustment provides optimal support in this context - and even accommodates treatment whilst the assistant is standing.

### Foot control and assistant element – Highlights and advantages for you:

- Relaxed easy and hygienic operation of chair, handpieces, and multimedia functions by foot
- Fatigue-free foot control due to left-right lateral movement
- Wireless remote foot control for more improved hygiene and more freedom of movement.
- Effortless, precise speed control with the MEMOdent function.
- Enhanced operation of the assistant element by direct selection keys
- Maximum flexibility is provided by the large range of movements and the adjustable height of the assistant element



*An investment into the future: The height adjustment of your assistant element ensures an ergonomic and healthy working posture and problem-free work procedures for your assistant.*

*The direct selection keys and comprehensive functions make your assistant element an „efficiency device“.*



# Perfect hygiene without compromise. Time-saving and easy.

## A clean issue, as seen from outside ...

Your KaVo ESTETICA E50 is very easy to clean. For disinfection, major parts, such as the silicone mat, handpiece holder, swing-arm clamp, and spittoon bowl, can be detached quickly. All surfaces are simple to clean, as are all contaminated parts in the aerosol-dispersal area. To ensure that no contamination enters your treatment centre, the top and bottom parts of the housing are completely sealed.

## ... perfect hygiene, looking at the inside.

The easy-to-clean suction filter system saves your staff additional time during the hygiene procedures. The suction filter is easy and safe to replace.

## Ensure the long-term operability of the treatment centre through the HYDRO-clean function.

Prevents clogged filters and obstructions in the suction system. Simply, manually activate the automatic programme for hydro-mechanical cleaning of the amalgam separator, suction, and drainage systems inside and outside of your treatment centre. Clean, fresh water dilutes blood and secretions reliably, to ensure that these contaminants do not become deposited in and block the suction system and drain. This process reduces breakdown time and costs that may arise from the servicing of amalgam separators and air/water separators.

## Easy and time-saving: DEKASEPTOL.

KaVo DEKASEPTOL gel is supplied pre-mixed and ready for use. This saves valuable time. DEKASEPTOL completely wets the lumens of suction hoses and systems and adheres to the contaminated regions, instead of merely passing straight through.

*Hygiene made easy: All surfaces are free of gaps and therefore easy to clean.*

# Safety has the highest priority. For everybody.

## Protect the lines from contaminated water.

DVGW has the strictest hygiene standards and KaVo fully endorses those standards. The water block with free water inlet of your KaVo ESTETICA E50 meets DVGW standards and prevents possible reflux contamination in your practice supply line. Moreover, permanent disinfection with KaVo OXYGENAL ensures permanent reduction of algae and micro-organisms. The supplementary intensive disinfection programme uses a higher OXYGENAL concentration and only takes approx. 45 minutes to complete. It protects your patients against micro-organisms that may form to an increased level of infestation, at times of extended stagnation, such as over weekends or holidays. Play it safe, e.g. after treatment of known, high-risk patients, through the use of the intensive disinfection cycle.

## Minimise the risks through the use of the rinsing programme in accordance with RKI.

Meet the requirements of the current RKI guidelines. For this purpose, your KaVo ESTETICA E50 performs standardised and automatic rinsing of the handpieces before you start working and after each patient.

## The non-return valve affords additional protection for everyone.

KaVo handpieces and motors are equipped with an automatic non-return valve, which reliably protects the water supply system. It prevents contaminated spray water from being aspirated into the treatment centre. You, your team, and your patients can feel safer.



*Grab handles, silicone mats, spittoon bowl, handpiece holders, and swing-arm clamps are easy to remove, disinfect and replace. The suction filters have hygienic handles which makes them easy and safe to clean/replace.*

## Easy and safe hygiene – Highlights and advantages for you:

- Automated and standardised hygiene
- Time-saving and easy cleaning, as the housing components are easy to remove, clean and replace
- Highest standard in accordance with RKI guidelines
- Additional safety afforded by non-return valve
- Improved hygiene since the top and bottom parts of the housing are close-fitting

# Simply clever. Planning today with a view to tomorrow.

## What does a treatment system have to include, to provide you with maximum flexibility in the future?

How can you ensure that your system continuously adapts to changes in your circumstances or areas of speciality? What happens when new treatment materials or methods become available? Which technologies need to be incorporated today? How could multimedia support you in your work? Which motor drives will complement your future handpiece investments? Which interfaces are best-suited to extend your system in the future?

Find the answers to all these questions on the following pages.

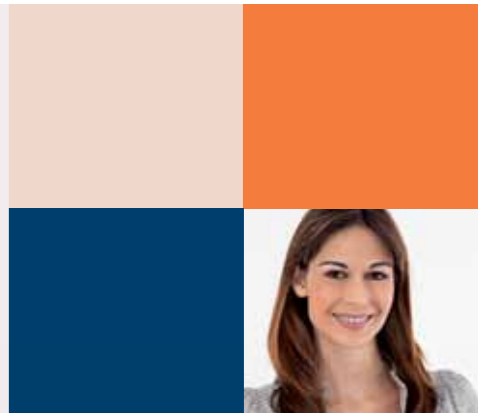
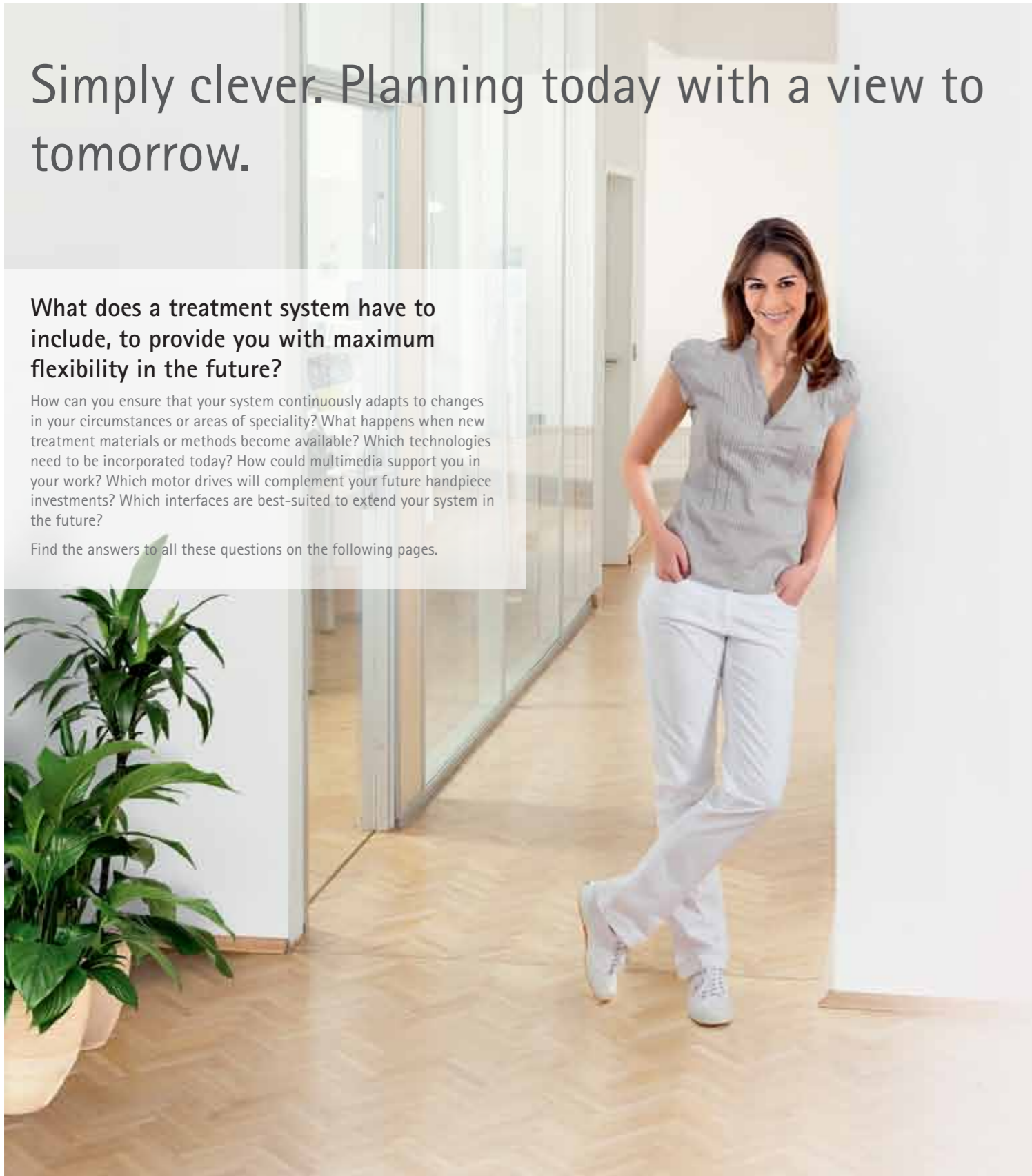

*There is no need to forego flexibility in the future when you choose a treatment centre. This is what makes the KaVo ESTETICA E50 the right choice for you.*

# Be open to innovation. The future is in your hands.

## Flexibility for the future due to exclusive KaVo advantages.

Do you know today what treatment focus you will have tomorrow? There is no need to limit yourself. Since only KaVo gives you the option to upgrade from five to six handpiece outlets on your treatment centre. You have complete freedom in your handpiece selection.



## SMARTdrive power and sensitivity conveying you into the future.

Precise, efficient, and time-saving working conditions are produced by the new SMARTdrive motor control, with full torque and particularly vibration-free start-up characteristics, even in the low speed range of 100 rpm. Due to the broader speed range, all straight and contra-angle handpieces may now be used in a more versatile manner, which extends the range of applications of each handpiece.

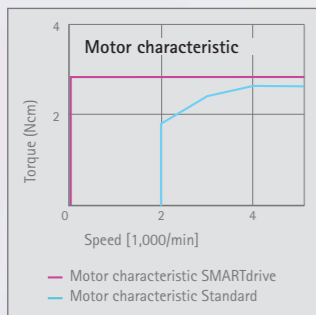

*Use the high torque and vibration-free start-up characteristics of your KaVo SMARTdrive with its extended speed range of 100 - 40,000 rpm to your advantage.*

## KaVo INTRA LUX KL 703 LED. A light weight for a balanced performance

With the new, maintenance-free, brushless micromotor KaVo INTRA LUX KL 703 LED, you will experience top performance. It is SMARTdrive-optimised and offers a wide speed range from 100 rpm to 40,000 rpm with a 1:1 „direct-drive“ handpiece. Thanks to its weight reduction of 30% and its 25% smaller design, it offers perfect ergonomics and optimum balance, with excellent distribution of weight. It offers more than just sufficient power for any treatment situation and enables more precise handling, with simultaneous stress-free working. For simple hygiene, the INTRA LUX KL 703 LED can be sterilised and features a long service-life, 25,000 LUX LED, for perfect illumination. Extraordinary performance characteristics, for extraordinary treatment results, day after day.



*KaVo INTRA LUX KL 703 LED: smaller, lighter and with perfect distribution of weight.*

## Treat your patients expeditiously and effectively with the PiezoLED.

The new PiezoLED scaler provides you with high-precision and effective tooth cleaning for your patients. KaVo CARE technology allows you to apply its power extremely evenly and with optimum linear tip movements, from a sinusoidal signal. Teeth and gingivae remain undamaged, even in delicate areas, due to the higher accuracy of your work.

The circular light array of the LED's produce optimum viewing conditions for you and in combination with the lightweight and ergonomic design, you can always treat your patients under ideal conditions.

*PiezoLED: Innovative KaVo CARE Technology with intelligent feedback control for the highest standard of patient treatment.*

## Power, speed, and lightweight design combined in your COMFORTdrive.

COMFORTdrive represents a new era of handpieces from KaVo. This drive combines the advantages of turbine and speed-increasing handpiece, into a single solution. Up to 200,000 rpm without a speed transmission gearbox, suitable for every preparation. And the COMFORTdrive is extremely lightweight in your hand. Its 40% lower weight makes your work much more relaxed. The centre of gravity is optimally balanced. Your hand and fingers are exposed to significantly lighter loads allowing you to work with extreme precision, for far longer.

## Stay flexible through the common interface, standard USB.



Simply connect additional selected USB devices through the USB interface of your KaVo ESTETICA E50. It is particularly easy as connecting a USB device usually necessitates no additional settings to be made. Your treatment centre automatically recognises what has been connected to it.

### Individualised features – Highlights and advantages for you:

- Integrated SMARTdrive for precise work in the low speed range
- KL 702 micro-motor and integrated torque control for endodontic work
- PiezoLED for effective and time-saving treatment of your patients
- Latest handpiece technology with COMFORTdrive for even more relaxed and efficient preparations
- Standardised interface for easy connection of external devices and flexibility for the future
- A wide selection of additional, intelligent features, which may be retrofitted in the future



*KaVo COMFORTdrive is your powerful, lightweight drive system, featuring a pleasant sound when in operation.*



# Face the future knowing: You are well-prepared.

## An investment into your personal future.

Your KaVo ESTETICA E50 is designed to support you ergonomically and ensure that all working procedures are efficient. Its time-proven and continuously improved components - such as the completely new electronics - is conclusive evidence of extremely high innovative power, functionality and formal quality. And you are well-prepared for the future.

## Bank on classical modern design.

Your treatment centre should continue to please you, your assistant, and your patients many years from now and always meet the highest visual demands. Utilise the modern design and attractive new colours to set the trends for your future.

## The service functions save you time and money now and in the future.

The integrated KaVo MEDIAGateway allows software updates, service checks, and future expansion to be carried out or implemented rapidly, effectively, and cost-efficiently.



# Everything is visible at one glance. Your entry into the digital world of dentistry.

## Realise speed and comfort through the ERGOcom multimedia system.

Connect all your systems easily: the computer at the practice, the treatment centre, and other media. Through this connection technology, you can call-up the most recent findings of your current patient on the 17" display of your KaVo ESTETICA E50 - together with the pertinent X-ray, microscope, and camera images or images from the PC. Without any delay and without you or your assistant having to leave the room. ERGOcom light is your simple, optional solution for this purpose.

## Your multimedia system is ready to go.

To use your ERGOcom light, you need neither a PC connection, nor do you have to lay cables. Its functions can be controlled either by foot control or through the dentist element of your KaVo ESTETICA E50.

## More light, more precision – intraoral images of supreme quality.

Increased vision means increased detection. Perfect intraoral images provide optimum support when treating patients. The new intraoral camera KaVo ERGOcam 5, provides detailed images with impressive depth-of-focus and excellent colour rendering. Thanks to state-of-the-art CMOS chip technology, you will get images of the very highest quality, in particular, in the area of the gingivae. Handling is easy and comfortable, thanks to the slide control and defined focus positions.

## ERGOcom light Multimedia – Highlights and advantages for you:

- Camera images may be displayed without a computer
- Simultaneous display of four camera images
- Camera, computer, microscope and x-ray images viewable on the treatment centre's monitor display
- Hygienic operation by foot control



*The ERGOcam intraoral camera gives patients the possibility of looking inside their own mouths. Take striking pictures, examine them, and magnify them – your efforts become palpable and comprehensible.*



*Automatic marketing of your services. Make use of potentially unproductive "waiting time" by informing your patients about the services that your practice offers.*

An easy decision:  
maximum quality for the  
highest standards.



**What does a treatment centre have to include, to allow you to fully rely upon it?**

What are the quality standards a manufacturer must observe to fully please you? Which features are required to enable you to make the right decision about a new treatment centre? Is it feasible to meet environmental standards despite the existence of strict hygiene requirements? And, what kind of design conveys to your patients that they can feel safe at all times?

Find the answers to all these questions on the following pages.

*Trouble-free work without breakdowns, day after day, even after many years, just like with a new treatment centre: The treatment centres from KaVo are known for their quality.*



# Simply designed perfectly. KaVo quality does not stop there.



## KaVo stands for proven and excellent quality.

Our standards for all KaVo products are extremely high. Only by maintaining these standards, are we able to meet the high expectations of our customers. For this purpose, our products are manufactured with high precision and have a sound design. Proven high-quality materials and components that have shown their benefits in practical application, ensure the reliability of your KaVo ESTETICA E50. Moreover, we subject each treatment centre to individual checks and comprehensive 100% tests. You are always on the safe side when you decide in favour of a KaVo ESTETICA E50.

## The overall concept of the KaVo ESTETICA E50 makes sound, clinical and commercial sense for you.

This treatment centre incorporates long-standing KaVo experience and high-quality, time-proven components. Our motto is to have confidence in what has proven itself and to steadily improve what is good about this treatment centre. This allows your KaVo ESTETICA E50 to successfully face the demands of the future. A perfectly sensible investment for you.

## KaVo quality – Highlights and advantages for you:

- Solid construction with superior materials
- Precise manufacturing according to the highest standards of quality
- Maximum reliability from comprehensive long-term tests
- Optimum quality at an affordable price

*Take DEKASEPTOL Gel for example: it is inert from an ecological point of view and biologically degradable according to OECD guidelines. It is totally free of aldehyde, phenol, and chlorine, and classified as a non-hazardous substance.*



## Protect the environment from the outset, in your practice.

Commentators on environmental protection are very aware that this important issue begins at home and includes protecting people from hazardous influences. It is therefore important to closely consider the materials and substances to which you and your staff are exposed every day. KaVo guarantees that your staff is fully protected in this respect. Our products are made in Germany and meet strict German environmental standards. Add to this an above-average service life, RoHS-compliance and electronics disposal that prevents the future release of hazardous substances.

*Its timeless design, practice-proven components, and modern functions are the foundation for the superior reliability of your KaVo ESTETICA E50.*

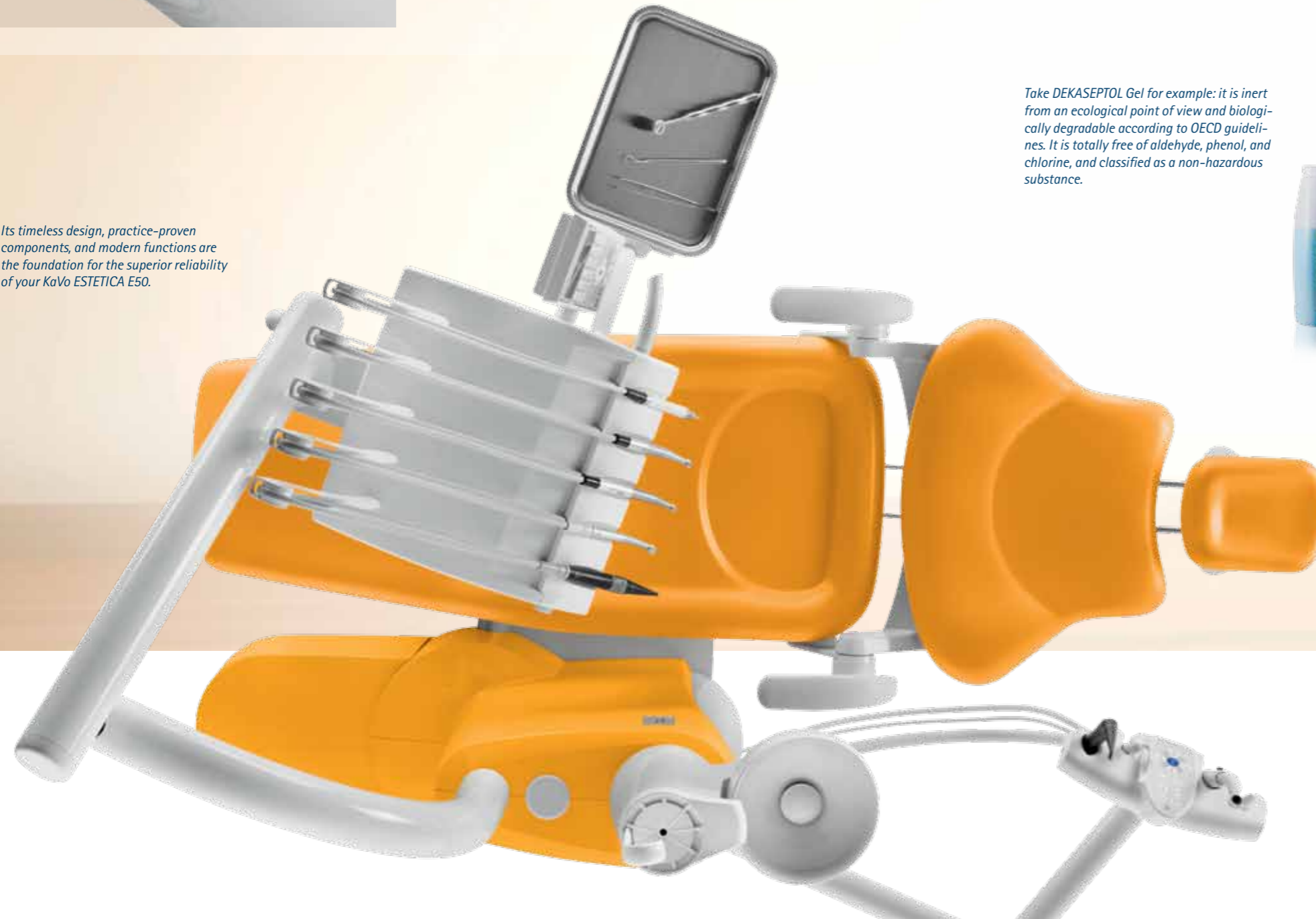

*Something you may rely on: Tested quality in accordance with the strictest standards throughout the world.*



# You have choices. Colour and additional equipment for your dental practice.

## Colours that establish trends.

Regardless of the future décor you envisage in your practice, the KaVo ESTETICA E50 is always available in a complementary colour scheme. Combine various upholstery and paint colours to suit your individual, aesthetic aspiration, enhancing your dental practice by selecting one of the new „Chrome Edition“ effect colours, such as Chocolate Brown or Night Blue.

### Paint



### NEW! Attractive KaVo colours.

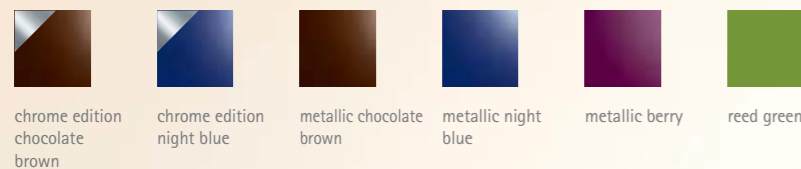

### Upholstery colours

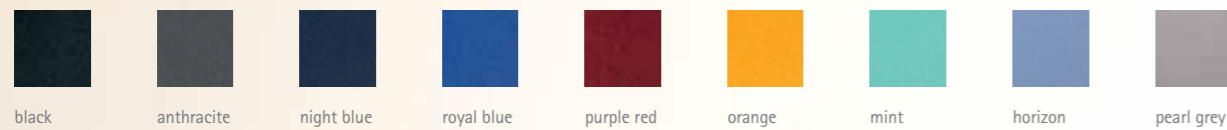

### NEW! Attractive KaVo colours.

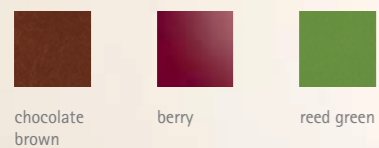

The elegant Chrome Edition colours feature not only chrome around the edges, but have both the patient and base sections of the chair painted in the new trendy colours.



# Take advantage of the many possibilities: create you own, bespoke treatment centre.

	TM	S		TM	S
<b>Patient chair</b>			<b>Assistant element</b>		
Standard	●	●	with Comfort control module	●	●
Height-adjustable seat	●	●	High Volume, aerosol aspirator	●	●
Soft upholstery	●	●	Saliva Ejector	●	●
			2nd Saliva Ejector	○	○
<b>Backrest</b>			3-function syringe	○	○
Progress	●	●	Multi-function syringe	○	○
			LED polymerisation handpiece	○	○
<b>Headrest</b>			Support for tray holder	○	○
Double-jointed with knob	●	●	Support tray for DIAGNOdent	○	○
Double-jointed with push button	○	○	Swivelling assistant element	●	●
Magnetic wedge attachment (for double-jointed headrest with push button)			Swivelling and height-adjustable assistant element	○	○
			Suction tube guide	○	○
<b>Armrest</b>			Isolation valve	○	○
Right	●	●			
Left	●	●	<b>Device body</b>		
			Spittoon bowl made of porcelain	x	x
<b>Dentist element</b>			Spittoon bowl made of glass	x	x
1st LUX turbine tubing	●	●	VACUstop	●	●
1st LUX micromotor KL 701	x	x	Permanent disinfection <sup>2</sup>	●	●
1st LUX micromotor KL 703	x	x	Intensive disinfection	○	○
3-function syringe	●	●	HYDROclean (rinsing system)	●	●
Multi-function syringe	○	○	Warm water heater	○	○
2nd LUX turbine tubing	○	○	MEDIAgateway	●	●
2nd LUX micromotor KL 701	○	○			
2nd LUX micromotor KL 703	○	○	<b>Supply system</b>		
SMARTdrive	●	●	DVGW water block	x	x
Integrated torque control (Endo)	○	○	Water block, compact	x	x
COMFORTdrive	○	○	DVGW pressurised water bottle	x	x
PiezoLED Scaler	○	○	Low-pressure regulator	○	○
MEMOdent multifunction display	●	●	Additional device connection	○	○
Small X-ray image viewer	○	○			
Panoramic X-ray image viewer <sup>1</sup> (mounted on the light post)	○	○	<b>Disposal system</b>		
Tray holder for US tray	x	x	External suction	x	x
Tray holder for single standard tray	x	x	DÜRR amalgam separator	x	x
Tray holder for 2 standard trays	●	●	Dürr automatic separator	x	x
Spray heating for handpieces	○	○	Solids collector	x	x
Physiological saline solution pump	○	○			
Anti-reflux valve for handpieces	●	●	<b>Miscellaneous</b>		
HF electrosurgery	○	-	Premium, wireless foot control	○	○
USB interface	○	○	KAVOLUX 1410 operating light	○	○
ERGOcam 5	○	○	Operating light mounting post	○	○
			Patient service box	○	○
			ERGOcom light	○	○
			DEKASEPTOL Gel – Basic Set	●	●
			Hygiene package	○	○

● Standard equipment ○ Optional equipment x Must be selected - Not available

<sup>1</sup> Not available in combination with multimedia  
<sup>2</sup> Available only with DVGW water block and DVGW water bottle



KaVo ESTETICA® E50



KaVo. Dental Excellence.

KaVo Dental GmbH · D-88400 Biberach/Riß · Telefon +49 7351 56-0 · Fax +49 7351 1103 · www.kavo.com